

LEX1

Digital precision gauge

Features

- Maximum accuracy / precision up to 0,01 %FS
- Insulated and encapsulated piezoresistive pressure sensor
- RS485 bus interface for communication with up to 128 devices
- Energy efficient, battery life up to 2000 operating hours
- Can be used with external power supply
- Free of license costs KELLER software as download
- Optional: Intrinsically safe version LEX-Ei available for use in explosive environments



Functions

- Wide range of pressure units to choose from
- Zero point calibration via button
- Automatic shutdown
- Min. / max. display
- User-defined pressure units configurable
- Digital calibration (zero point, end point)

Typical applications

- Calibration
- Laboratory use
- Industrial applications

Accuracy

± 0,05 %FS

Total Error Band

± 0,05 %FS

Pressure Ranges

-1...1 bar to 0...1000 bar

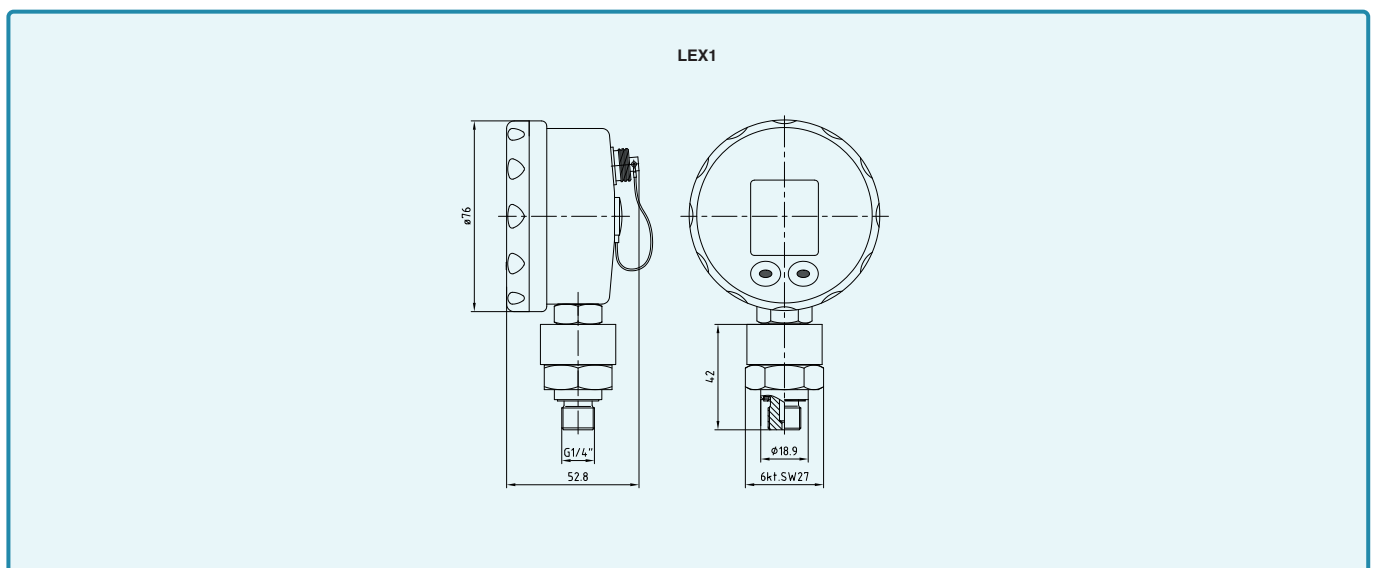

LEX1 – Specifications

Standard pressure ranges LEX1

Relative pressure PR	Absolute pressure PAA	Absolute pressure PA	Proof pressure	Display resolution
-1...1	0...2		8	0,0001
-1...3	0...4		8	
-1...6	0...7		20	
-1...10	0...11		30	0,001
-1...16	0...17		90	
-1...30	0...31		90	
	0...61		300	0,002
	0...101		300	0,01
	0...161		600	
		0...300	600	
		0...400	800	0,02
		0...700	1100	0,05
		0...1000	1100	0,1
bar rel.	bar abs.	bar abs.	bar	bar
Reference pressure at atmospheric pressure	Reference pressure at 0 bar abs. (vacuum)	Reference pressure at 1 bar abs.	Based on reference pressure	

Performance

Accuracy @ RT (20...25 °C)	$\leq \pm 0,05$ %FS	Nonlinearity (best fit straight line, BFSL), pressure hysteresis, non-repeatability, zero point deviation and amplification deviation
Total error band (0...50 °C)	$\leq \pm 0,05$ %FS	Max. deviation within the compensated pressure and temperature range
Compensated temperature range	0...50 °C	
Long-term stability	$\leq \pm 0,1$ %FS	> 1 bar, per year under reference conditions, yearly recalibration recommended
	$\leq \pm 1,0$ mbar	≤ 1 bar, per year under reference conditions, yearly recalibration recommended
Position dependency	$\leq \pm 1,5$ mbar	Calibrated in vertical installation position with pressure connection facing downwards
Pressure range reserve	± 10 %	Valid measured values outside the pressure range, no overflow / underflow yet.
Accuracy of temperature measurement	± 1 °C typ.	

LEX1 – Specifications

Increased Precision / Accuracy (optional)

If customers choose, KELLER can achieve the highest degree of reproducibility (precision) for certain products by increasing the amount of measurement work it undertakes and selecting corresponding pressure transducers. In addition, some products can be adjusted to their higher accuracy pressure sources by an accredited calibration laboratory. The specifications for increased precision only refer to the digital interface RS485. See the more comprehensive descriptions below for more details.

Limitations:

- Only for absolute pressure PAA / PA
- Only for standard pressure ranges ≥ 10 bar
- Analog output 4...20 mA excluded

Precision @ RT (20...25 °C)	$\leq \pm 0,01$ %FS	With KELLER test report ex works
	$\leq \pm 0,025$ %FS	
Accuracy @ RT	$\leq \pm 0,01$ %FS	With DakkS (German accreditation body) certificate issued by external calibration laboratory
	$\leq \pm 0,025$ %FS	

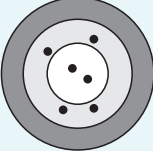
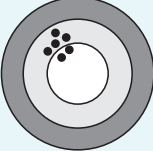
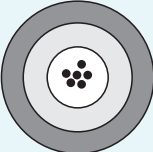
	<p>Accuracy $\pm 0,05$ %FS, with KELLER test report ex works (standard)</p> <p>Keller uses pressure sources to calibrate its products that are at least four times more accurate than the product to be tested. This enables us to produce products in our factory with an absolute accuracy of up to $\pm 0,05$ %FS.</p>
	<p>Precision $\pm 0,01$ %FS / $0,025$ %FS, with KELLER test report ex works</p> <p>Additional measurement work and selection of a specific pressure transducer means that optimum repeatability is guaranteed for selected pressure transmitters and digital manometers. Owing to the residual measurement uncertainty of the pressure sources used at its factory, KELLER cannot provide any verification of measurement accuracy at scales below $\pm 0,05$ %FS for these ultra-precise devices. KELLER therefore uses the term "precision" to denote the ability of a pressure transmitter or manometer to repeat measured values within a tolerance of $0,01$ %FS based on the pressure sources used at the factory.</p>
	<p>Accuracy $0,01$ %FS / $0,025$ %FS with DakkS (German accreditation body) certificate, issued by an external accredited calibration laboratory</p> <p>By calibrating the zero point and performing amplification via the digital interface, an accredited calibration laboratory (ilac.org) can adapt ultra-precise KELLER products to their more accurate pressure sources and record the results. External calibration to an accuracy of up to $\pm 0,01$ %FS is performed in accordance with the guidelines set out by the German Calibration Service (DKD) and is conducted under reference conditions without any consideration of long-term effects.</p>

LEX1 – Specifications

Electrical Data

Battery	3 V, type CR2430	LEX1-Ei only permitted for use in hazardous atmospheres when used with the Renata CR2430
Battery life	approx. 2000 hours	When used continuously
External power supply	8...28 VDC	LEX1-Ei devices can supplied with power from an external source RS485 interface must not be used in the Ex zone See operating instructions for further information
Overvoltage protection and reverse polarity of external power supply	± 32 VDC	
RS485 voltage insulation	-7...12 VDC	
GND case insulation	> 10 MΩ @ 50 VDC	
External interface	RS485 half-duplex	
Interface measuring rate	15/s	
Electrical connection	Flange socket D 103 A054-130	

Electromagnetic compatibility

CE conformity as per 2014/30/EU (EMV)	EN 61326-1 / EN 61326-2-3 / EN 61000-6-1 / EN 61000-6-2 / EN 61000-6-3 / EN 61000-6-4
---------------------------------------	---

LC-Display

Dimensions/appearance	Width x height: 27,8 x 30,0 mm (see Dimensions and options)
Number of digits on LC display	2 rows with 5 digits each
Display mode	Pressure + min / max
Display interval	2/s
Configurable units of pressure	bar, mbar, hPa, kPa, MPa, PSI, mH ₂ O, cmH ₂ O, inH ₂ O, ftH ₂ O, mmHg, inHg, kp/cm ²
Additional units of pressure	5 user-defined units can be configured

LEX1 – Specifications

Mechanical Data

Materials in contact with media

Pressure connection	Stainless steel AISI 316L	
Pressure transducer separating diaphragm	Stainless steel AISI 316L	
Pressure transducer seal (internal)	FKM	For media temperatures < -20 °C, FVMQ (70 Shore, -60...175 °C) is used
Pressure connection seal (external)	FKM (75 Shore, -20...200 °C)	Optional: EPDM (-40...125 °C)

Other materials

Display housing	Faradex AS-1003
Front glass	LEXAN® 163R
Oil filling pressure transducer	Silicone oil

Further details

Pressure connection	G1/4, see Dimensions and Options
Diameter x height x depth	76 mm 118 mm x 55 mm
Weight	approx. 300 g

Ambient conditions

Media temperature range	-40...85 °C	Icing not permitted
Ambient temperature range	-10...60 °C	
Storage temperature range	-20...70 °C	
Protection	IP65	
Notes	Readability of the LC display is guaranteed between 10 °C and 50 °C Outside this range, the display can only be read to a limited extent	

Explosion Protection LEX1-Ei

Intrinsically safe version in accordance with 2014/34/EU (ATEX) and IECEx	Ex II 2G Ex ia IIC T6 Gb PTB 05 ATEX 2012 X IECEX PTB 13.0028 X	The intrinsically safe version LEX1-Ei may only be operated with the 3,0 V battery, CR2430 from Renata Approved max. ambient temperature range -20...65 °C
Note	The conditions for safe use can be found in the operating instructions	

LEX1 – Dimensions and Options

LC-Display

Front Cover	Content	Dimensions
		Width × height: 27,8 × 30,0 mm Digit height: up: 8,4 pt. large below: 6,3 pt. small

External Connection

Placement	Connection	Pin assignment												
	Flange socket D 103 A054-130 													
		<table border="1"> <thead> <tr> <th>Red</th> <th>Reference point</th> </tr> </thead> <tbody> <tr> <td>1</td> <td>GND</td> </tr> <tr> <td>2</td> <td>n.c.</td> </tr> <tr> <td>3</td> <td>+Vs</td> </tr> <tr> <td>4</td> <td>RS485A</td> </tr> <tr> <td>5</td> <td>RS485B</td> </tr> </tbody> </table>	Red	Reference point	1	GND	2	n.c.	3	+Vs	4	RS485A	5	RS485B
Red	Reference point													
1	GND													
2	n.c.													
3	+Vs													
4	RS485A													
5	RS485B													

Available Pressure Connections

G1/4 (standard)	G1/2	1/4-18NPT	1/2-14NPT	G1/2 mano
DIN EN ISO 1179-2	DIN EN ISO 1179-2	ASME/ANSI B 1.20.1	ASME/ANSI B 1.20.1	DIN EN 837-1
G1/2 front flush	G3/4 front flush	7/16-20 UNF	Tri-Clamp 1 1/2"	G1/4 mano
EN ISO 228-1	EN ISO 228-1	ISO 12151-5	DIN 32676	DIN EN 837-1

Other pressure connections available upon request.

LEX1 – Dimensions and Options

Other Customer-specific Options

- Other compensated pressure ranges
- Other compensated temperature ranges
- Parts that come into contact with media made from Hastelloy, Inconel or titanium
- Customer-specific front covers
- Integration of application-specific calculations
- Customer-specific firmware
- Detached pressure transducer
- Axial pressure connection
- Other sealing materials
- Other oil fillings pressure transducer

LEX1 – Software

Interface

The LEX1 manometer has a digital interface (RS485 half-duplex) which supports the KELLER bus protocol. Details of the communication protocols can be found at www.keller-druck.com. Documentation, a Dynamic Link Library (DLL) and various programming examples are available to integrate the communication protocol into your own software.

Interface Converters

The connection to a computer is established via an RS485-USB interface converter. Suitable converters are available as accessories. To ensure smooth operation, we recommend the K-114 A converter with the corresponding USB connector.

«ManoConfig» Software

The ManoConfig program is compatible with various types of KELLER manometers and allows end customers to configure the devices.

Range of functions

- Configuring the wait period before automatic shutdown
- Activating/deactivating pressure units
- User-defined pressure units can be programmed
- Calibrating the manometer

«CCS30» Software

Recording measured values



- Live visualisation
- Adjustable measuring and storage interval
- Export function

Configuration





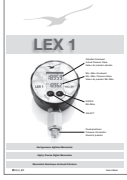

- Call up of information (pressure and temperature range, firmware version, serial number etc.)

LEX1 – Scope of Delivery and Accessories

Scope of Delivery

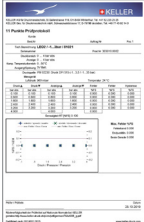
Plastic case	CR2430 battery	KELLER 5-point report	Operating instructions D/E/F
			

Accessories

Rubber cover	Carry case	KELLER 11-point report	Calibration certificate
			
For additional protection in harsh environments	With belt loop	Measurement deviation at room temperature with hysteresis	Issued by the external calibration laboratory of the German accreditation body DAkkS or the Swiss accreditation body SAS
Interface converters			
			
K-114 A <ul style="list-style-type: none"> • With Fischer plug (5-pin) • Various adapter cables available 	K-114 BT A <ul style="list-style-type: none"> • with Bluetooth interface and integrated rechargeable battery • Wireless connection via Serial Port Profile (SPP) • 15 V measuring device supply from the converter's internal battery 		