



FK120J for humidity
 TFK120J for humidity and temperature

Technical Data

measuring range **humidity** 0...100%rh
 working range 10...95%rh
 measuring accuracy ±3.5 %rh
 measuring medium..... air, pressureless, non-corrosive/condence
 temperature coefficient 0.05%/K at 20°C and 50%rh
 adjustment at average air pressure 430m NN
 half-life period (v=2m/sec) approx. 10 sec
 output **humidity** 0...20mA or 0...10V 4-wire system
 or 4...20mA 2-wire system
 measuring range **temperature**
 0...+50°C, -10...90°C¹, -30...60°C, 0...100°C¹
 measuring accuracy ±0.8K
 working range -10...+60°C
 output **temperature** 0...20mA or 0...10V 4-wire-system
 or 4...20mA 2-wire-system
 linearity tolerance <0.5%
 operating voltage 15..24V DC / 24V AC
 max. load for current output 500 ohms
 min. ballast resistance for voltage-output 10 k ohms
 internal consumption per measuring range (4-wire) 15 mA
 permissible ambient temperature -10...60°C
 permissible air speed 15 m/sec.
 fixing slots in housing base for wall mounting
 mounting position preferably ventilation slots at right-
 angles to wind direction
 contact connecting terminals in the housing
 connecting terminals
 for conductor cross-sections 1.5mm²
 cable connection simple shielding
 EMC tested to EN 50 081-2, EN 50 082-2
 housing impact resistant plastic, light grey
 dimensions 115x70x43mm
 protective system IP20
 weight ca 0.2kg
 "subject to technical modifications"

1) please heed working range

Humidity Sensor type FK120J (capacitive)
 with current or voltage output, to determine air humidity in room version.

Humidity-temperature Sensor type TFK120J (capacitive)
 with current or voltage output, to determine air humidity and temperature in room version.

Description of the sensors

The FK120J (humidity only) / TFK120J (humidity and temperature) sensor measures the air humidity by means of a humidity-dependant condenser. The capacitive humidity measuring element, produced using thin-film technology, consists of a base plate, on which the electrodes are housed, and a hygroscopic polymer layer above it. The hygroscopic polymer layer absorbs water molecules from the medium to be measured (air) or releases them, thereby altering the capacity of the condenser. In a tandem-arranged electronic device, the change in capacity is processed via integrated signal preprocessing into standardised signals **0...20mA** or **0...10VDC** or **4...20mA**.

The measuring element is protected in the housing. The sensors are designed for pressureless systems - the measuring medium is non-corrosive air.

The TFK120J sensors also contain a Pt100 resistance for simultaneous temperature measurement. Its measured values are likewise converted into standardised signals **0...20mA** or **0...10VDC** or **4...20mA**.

Maintenance

The measuring element is maintenance free when the surrounding air is clean. Agents that are corrosive and contain solvents, depending upon the type and concentration of the agent, can result in faulty measurements and cause the measuring element to break down. Substances deposited on the sensor are damaging as they form a water-repellent film. Such substances are resin aerosols, lacquer aerosols, smoke deposits etc.

Please consult the **application instructions** for the sensing elements (product info sheet no. A 1) or check with the manufacturer for further information which you need to bear in mind when using humidity sensors with capacitive sensing elements.

ATTENTION: The guarantee is no longer valid if the interior of the measuring element has been accessed.

This information is based on current knowledge and is intended to provide details of our products and their possible applications. It does not, therefore, act as a guarantee of specific properties of the products described or of their suitability for a particular application. It is our experience that the equipment may be used across a broad spectrum of applications under the most varied conditions and loads. We cannot appraise every individual case. Purchasers and/or users are responsible for checking the equipment for suitability for any particular application. Any existing industrial rights of protection must be observed. The perfect quality of our products is guaranteed under our General Conditions of Sale. Issue : March 2008 valid until 31.12.2009 FK120J_E. Subject to modifications, current version available at www.galltec.de. This issue supersedes all previous technical leaflets.

Overview of *capacitive* sensors operating voltage = 15...24V DC and/or 24V AC

FK120J	0...100%rh	0...10VDC			15...24 VDC 24VAC	3/4wire	59014700
	0...100%rh	4...20mA			15...24VDC	2wire	59014800
TFK120J	0...100%rh	0...20mA	0...+50°C	0...20mA	15...24VDC	3/4wire	59523030
	0...100%rh	0...10VDC	0...+50°C	0...10VDC	15...24 VDC 24VAC/DC	3/4wire	59524747
	0...100%rh	4...20mA	0...+50°C	4...20mA	15...24VDC	2wire	59524848
	0...100%rh	4...20mA	-30...+60°C	4...20mA	15...24VDC	2wire	59574848
	0...100%rh	0...20mA	0...+50°C	0...20mA	24VAC	4wire	59524242
	0...100%rh	0...20mA	-30...+60°C	0...20mA	24VAC	4wire	59574242
	0...100%rh	0...20mA	-10...+90°C*	0...20mA	24VAC	4wire	59624242
	0...100%rh	0...20mA	0...100°C*	0...20mA	24VAC	4wire	59544242

* observe max. temperature range

Connection diagram

EMC-information: use shielded signalling lines and earth the shielding!

3/4-wire system

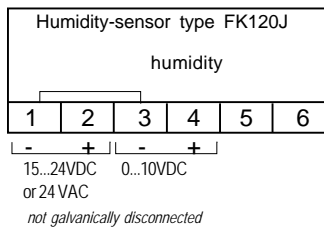

2-wire system

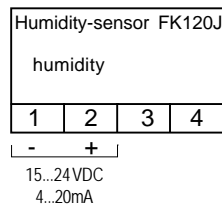

2-wire system

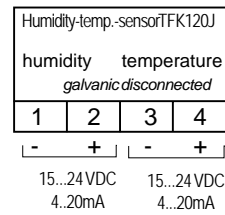

3/4-wire system

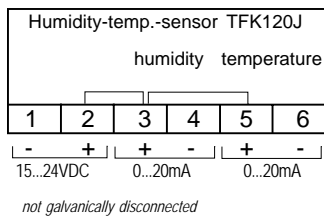

3/4-wire system

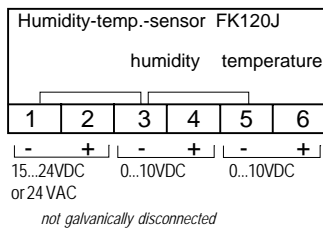

4-wire system (AC-version)

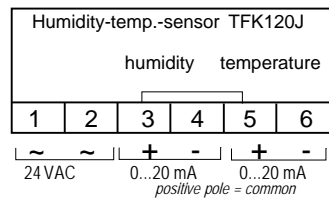

The electrical connection must only be carried out by properly qualified personnel.

Dimensions diagram

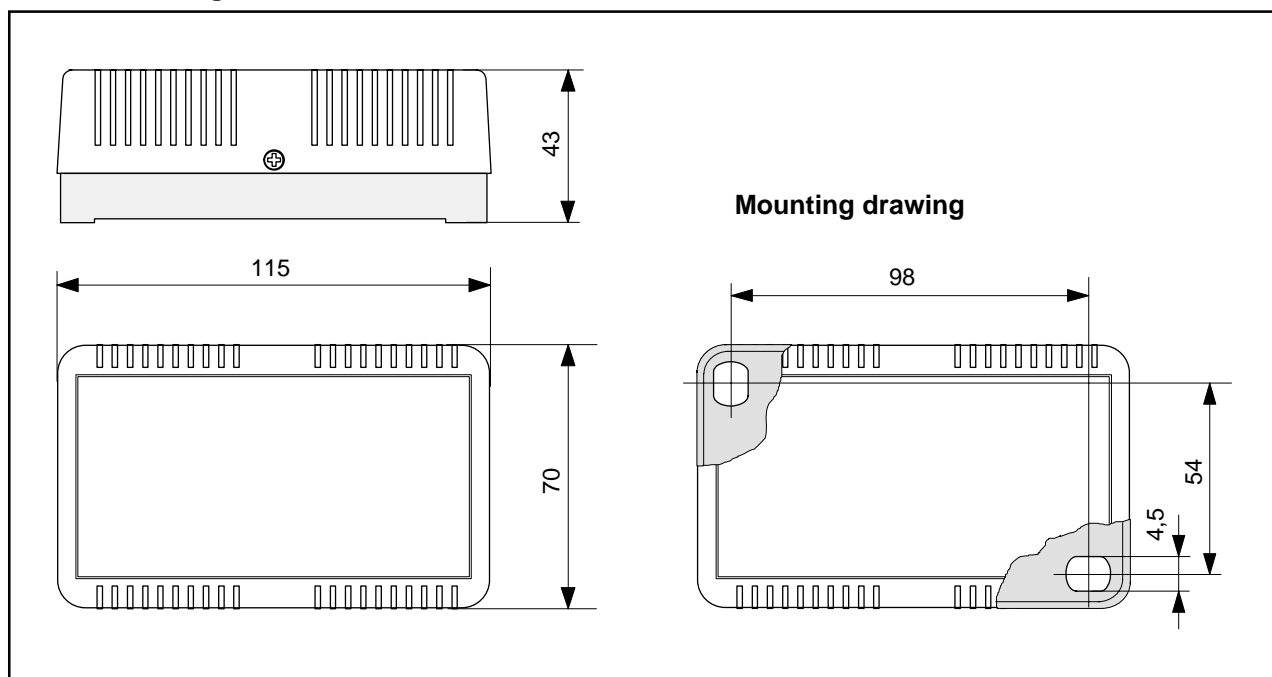

Mounting instructions

The room sensor should be mounted on a vertical wall about 1.5m above the floor.

Do not fit above radiators, near windows or doors, on areas exposed to intense vibration or direct sunlight, exterior walls or chimneys. Under no circumstances must the sensors be mounted into a wall or niche. The sensors should be protected from dripping water or splashes. Ensure that no air can flow into the interior of the housing via the concealed cable lead. Do not use a silicon sealing compound to seal the cable lead.

The sensors should be mounted such that air in the room can flow upwards unimpeded through the ventilation slots in the housing cover.

The temperature coefficient as well as the self-heating of the electronic may vary according to the location and the application (especially with sensors where electronic and measuring system are integrated in one housing).

Guide to installation

Interference is often to be encountered during installation. The correct installation procedure can prevent interference to a very large extent. However, some ground rules should be observed.

To avoid interference, suppression should be carried out in accordance with VDE 0875 and VDE 0874

(VDE - this is assumed to be the *Vorschriftenwerk Deutscher Elektrotechniker* - regulations governing German electrical engineers).

Fundamentally, interference must be removed at its source, where suppressor material is most effective. Interference can, however, also result from electromagnetic fields via signalling lines. The EMV law determines the corresponding protective measures. All Galltec equipment is designed in accordance with European standards EN 50081-2 and EN 50082-2 (for industrial locations). In addition, further protective measures must be observed.

Unavoidable sources of interference should be kept at a good distance from the control systems.

Data and signalling lines should not be used in parallel with control, networking and power lines.

For data and signalling lines, shielded cable should be used, and the shielding must be applied to the earth terminal. Ensure that earth circuits and fault currents do not arise as a result of a second earth connection.

For equipment with a network connection, it is recommended that a separate network circuit be used.

During the switch process, electrical power consumers such as switch contactors, magnetic valves etc. produce induction voltages that can cause interference. In the trade there is an abundance of protective and suppressor component parts that are most effective when applied directly to the source of the trouble. A suitable suppressor has the added advantage that components such as relays, microswitches etc. have a longer service life.

Further difficulties during installation can arise if signalling lines are joined together with common lines. It is essential to check whether this is permissible. Interference is particularly likely when installing using equipment of different makes. Here, too, the trade offers isolating amplifiers that overcome the problem.